

● Light and durable raised resin floor system

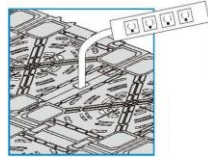

Key features

- Good for offices with a lot of wiring
- Cables and cords can be routed under panels
- Easy wiring when changing the room layout
- Wire pass channels
- Easy installation just by placing
- Lightweight
- 3000N Max Load



Recommended finishing materials is carpet

● Products

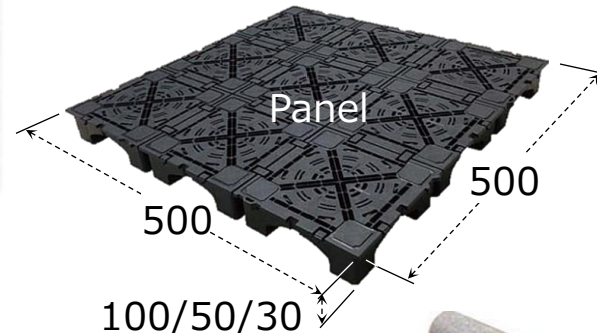

(Optional parts)



Slope



Sheet under the panel











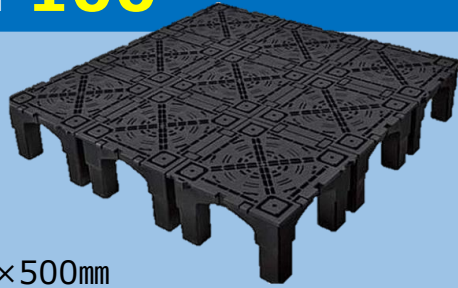
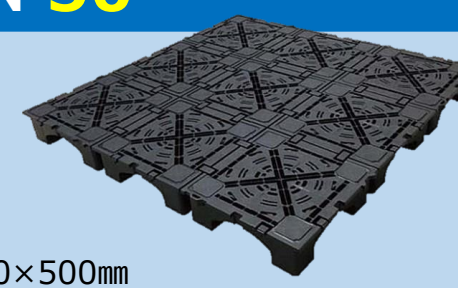
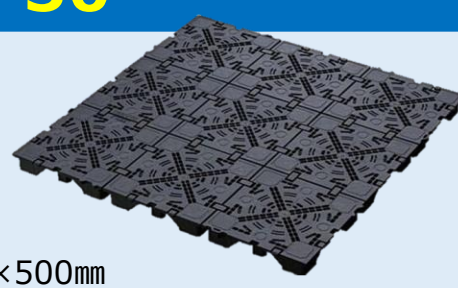
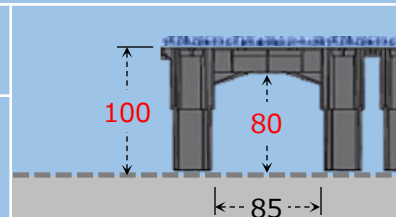
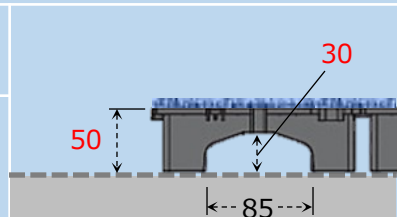
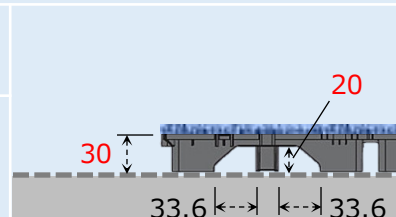

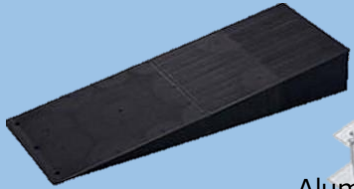

Additional leg

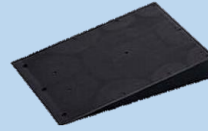

Aluminum end cover

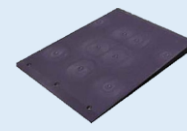
- Material : PP
- Color : Black
- Size : 500×500×Height 100mm
500×500×Height 50mm
500×500×Height 30mm
- MOQ : 1m² (4pcs)

	TN-100		TN-50		TN-30	
Panel	 <p>PP 500×500mm</p>		 <p>PP 500×500mm</p>		 <p>PP 500×500mm</p>	
Panel Height	100mm		50mm		30mm	
Height of the space under the panel	80mm		30mm		20mm	
						
Weight	8.9kg/m ²		6.8kg/m ²		5.6kg/m ²	
Max Load	3000N (≒306kg)		3000N (≒306kg)		3000N (≒306kg)	
Accessories	 <p>Additional leg 100S</p>  <p>Sheet under the panel Width 1m×20m roll</p>  <p>Slope 100 Width250×Length668mm</p>  <p>Aluminum end cover Length2m</p>		 <p>Additional leg 50S</p>  <p>Sheet under the panel Width 1m×20m roll</p>  <p>Slope 50 Width250×Length333mm</p>  <p>Aluminum end cover Length2m</p>		 <p>Additional leg 30S</p>  <p>Sheet under the panel Width 1m×20m roll</p>  <p>Slope 30 Width250×Length333mm</p>  <p>Aluminum end cover Length2m</p>	

● If you use FUKUVI's OA Flooring...



Have space

Easy to wire
No damage to the floor



Plastic product

Easy to cut
Less dust and noise



Light weight

Easy to carry
Less burden on the body
Less load on the floor

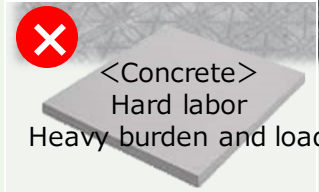

● Installation

① Lay a sheet on the floor

- Clean the floor
- Do not overlap seams
- Fix the seams with adhesive tape

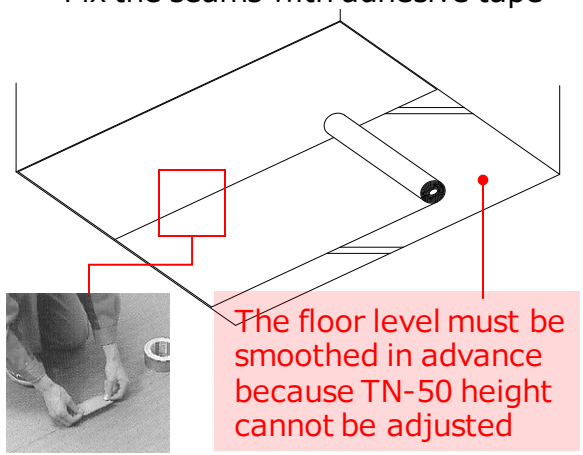

② Line up the base panel

• 4mm away from the wall

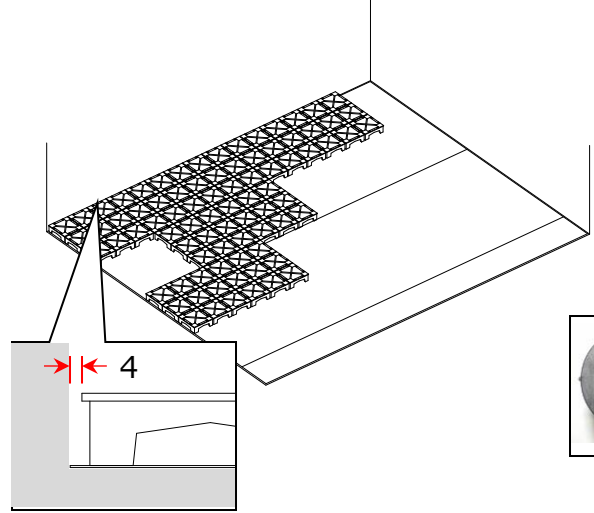

③ Attach additional leg to the back of the cut base panel

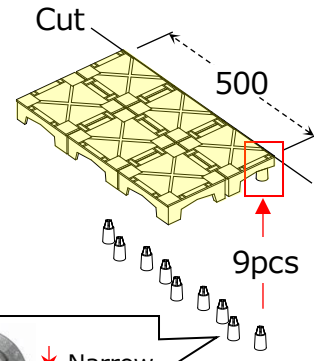

- Insert a narrow groove into the rib on the back
- Install 9 pieces for a length of 500mm

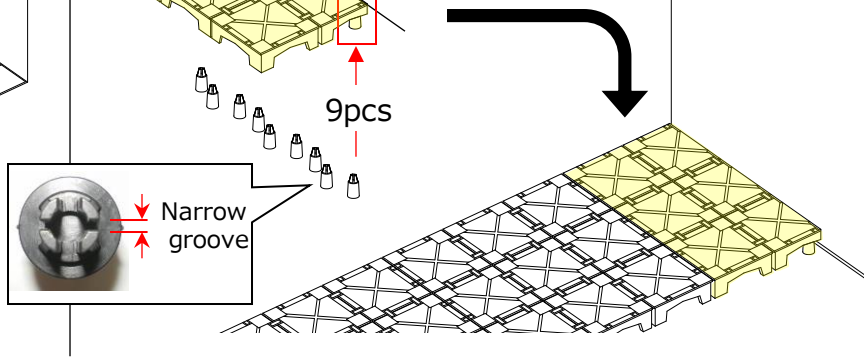

④ Attach the aluminum end cover line on the side of the slope installation position

1. Attach to floor with concrete screws
2. Attach to a base panel with general screws

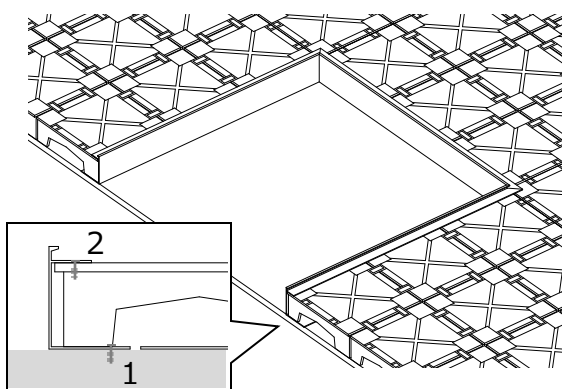

⑤ Fix a slope

1. Stick it on the floor with double-sided tape
2. Attach with concrete screw

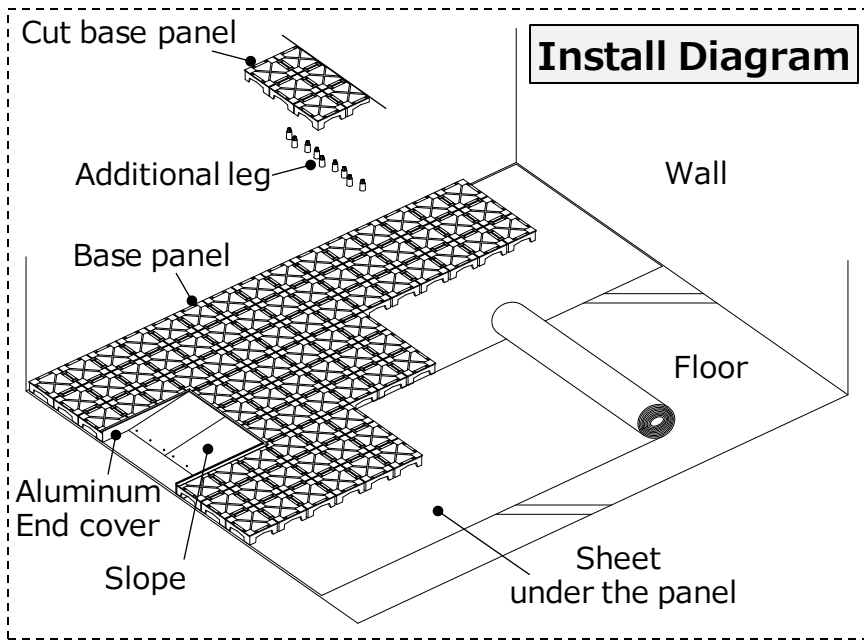
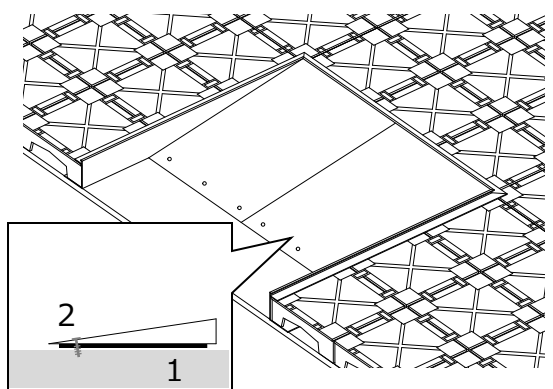

● Construction example <OA Flooring TN-50>

■ OFFICE (BANGKOK/THAILAND)

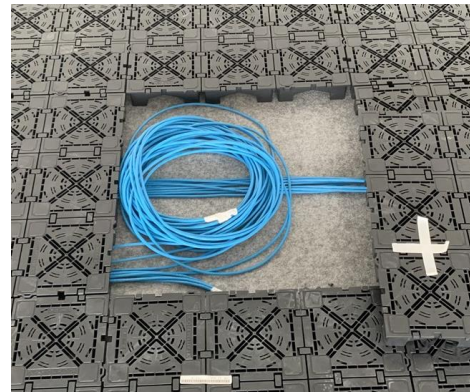

● Construction example <OA Flooring TN-100>

■ OFFICE (HO CHI MINH / VIETNAM)

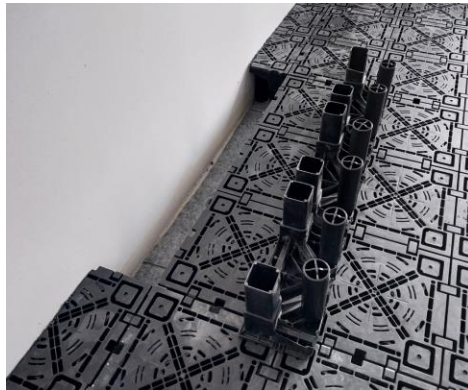
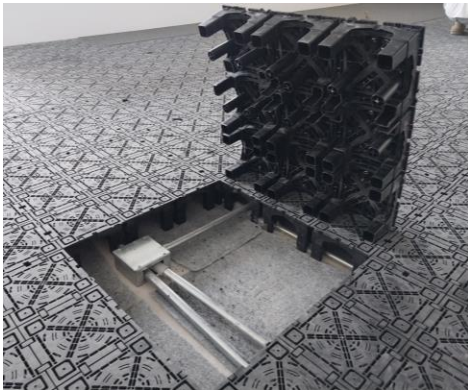
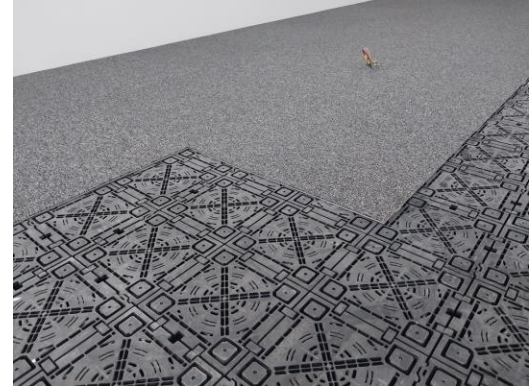

● Construction example <OA Flooring TN-100>

■ FACTORY OFFICE (BINH DUONG/VIETNAM)

