

TENKENKO - 1G

Inspection Opening Frame

TENKENKO has been an irreplaceable line of products used in residential, commercial, and industrial construction in Japan, for decades. The TENKENKO - 1G model was designed to provide easy access to the wall cavity for inspection of plumbing pipes and any other essential functional components. The design blends in naturally with the wall and doesn't draw attention, making it a simple addition to your project. By using paint or wallpaper on the gypsum board, that is inserted into the frame, our customers can further reduce the visibility of the access panel. The simple latch mechanism makes the insertion and removal of the lid completely hassle free. High quality materials and strict quality control used in the manufacturing of the product ensure longevity and reliability our customers can depend on. Meticulously designed and tested to meet the rules and regulations, and the high expectations of the international market.



Features



Quick Installation
Easy 6-Step Installation



Lightweight
Designed to be lightweight



PVC
Made of PVC material with stable physical properties



Easy Access
Easy access to interior by simply raising the lid to remove.
No clips or locks.



Paint/Wallpaper
Compatible with painted & wallpapered wall board



Clean/Straight Lines
Perfectly hides unfinished & uneven edges at opening area



MADE IN VIETNAM



Product List

Model	Design	Dimensions	Color	MOQ
Tenkenko - 1G	300	see page 2	White	10pcs

Note: The dimensions listed for this product are the dimensions of the usable opening after installation. The cut in the installation surface, prior to installation, will require an additional 30mm to be added to each dimension, i.e. 1G 300 requires a cut opening of 330x330mm for a finished usable opening of 300x300mm.

Model Design

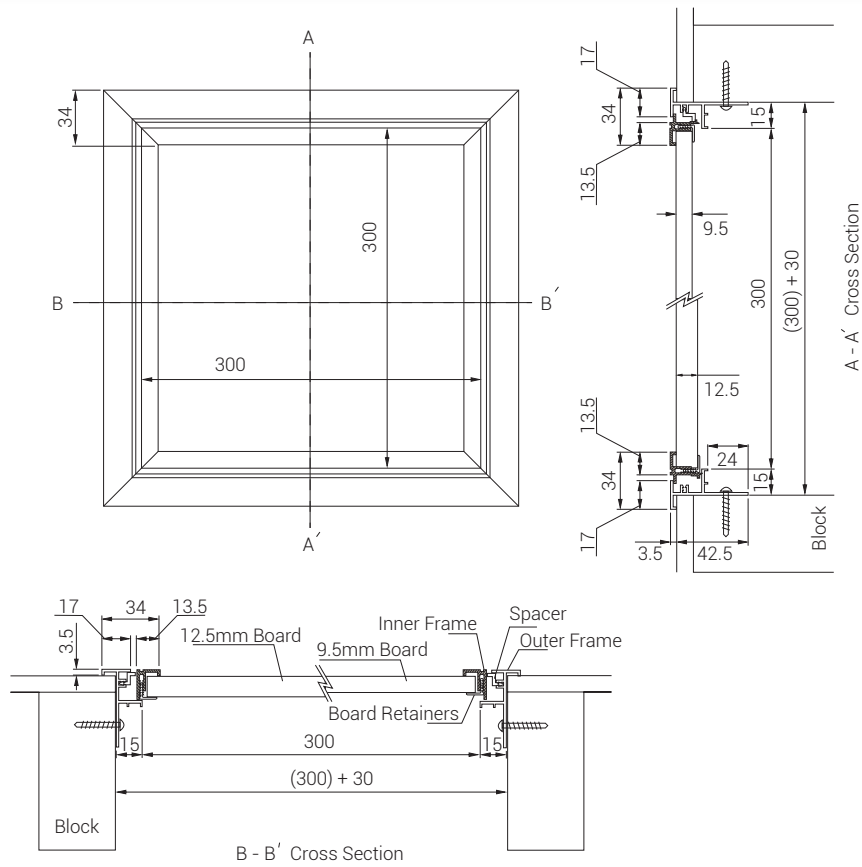

Note: All models fit 9.5mm and 12.5 board.

Installation Guide

1

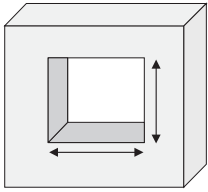

Cut an opening in the installation surface (wall) to the appropriate size.
330x330mm

2

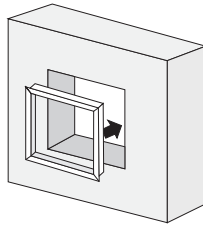

Insert the outer frame.

3

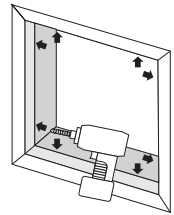

Drill holes into the wall using the frame holes as guides (8 places).

4

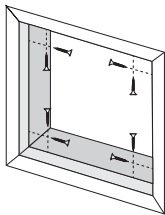

Secure with screws on the inside the frame (8 screws).

5

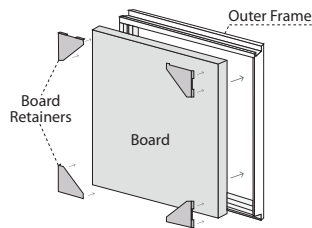

Create the lid (insert the board into the inner frame and attach it with the board retainers).

6

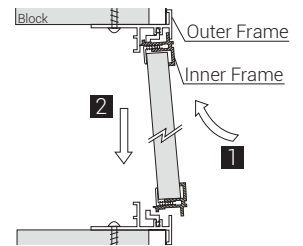

Close the lid following step 1 and step 2.